



KAY PARK RECREATION

MAKING PLACES PEOPLE FRIENDLY • **SINCE 1954**
(800)553-2476 • sales@kaypark.com
1301 Pine St. Janesville, IA 50647

6' Diamond Bench

Model #: **PSDB6**

Weight: **265 Lbs**

Material: **Perforated**



top view

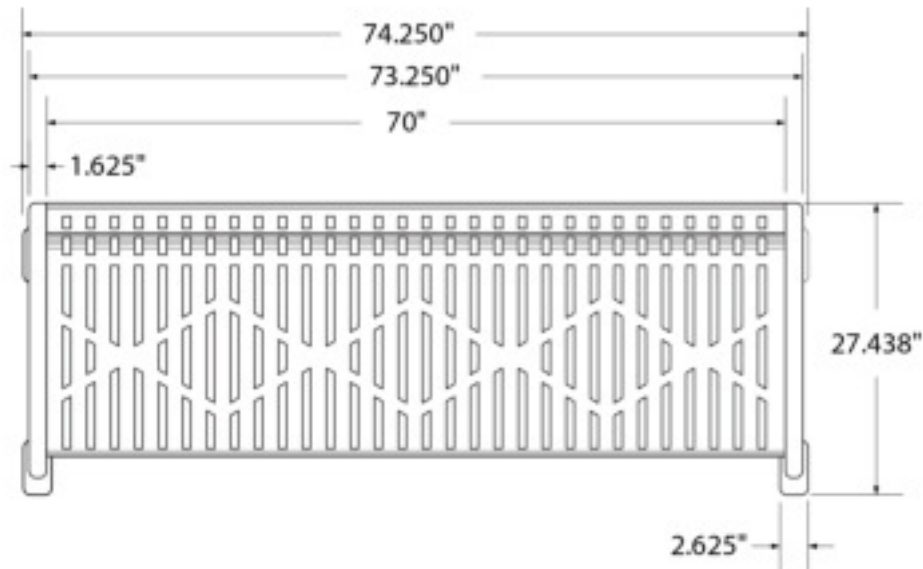

front view

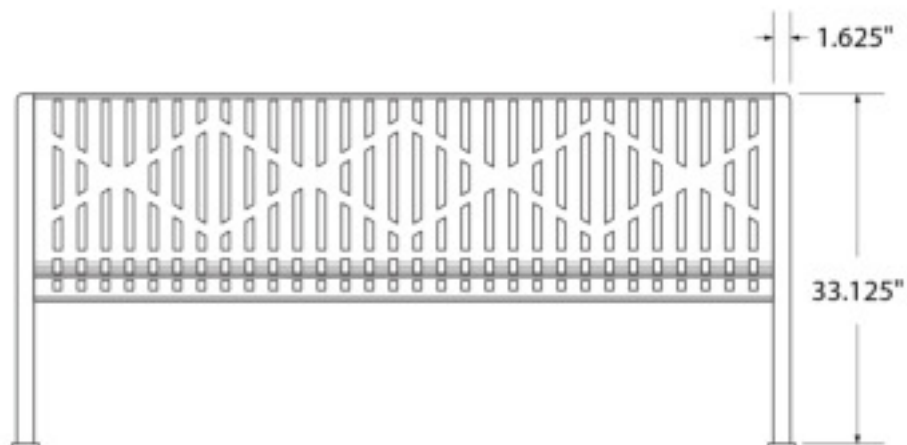

side view

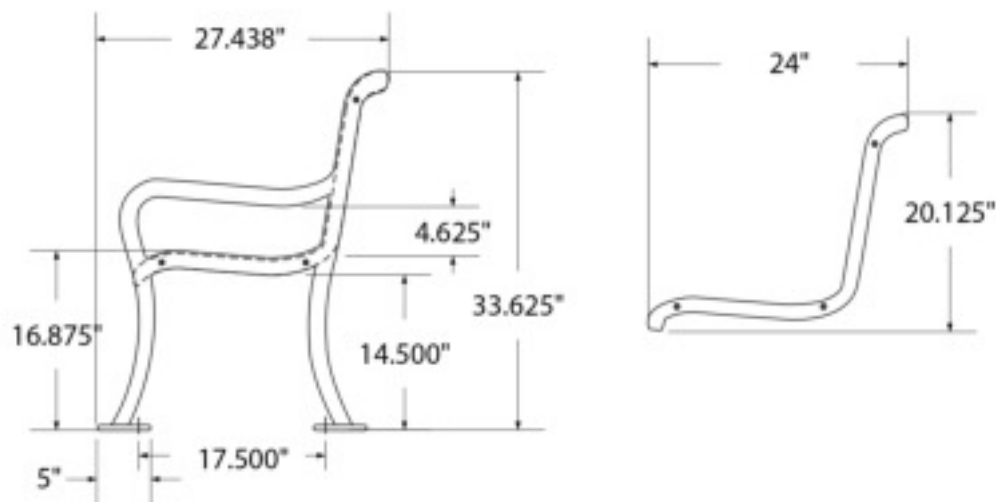

product finish

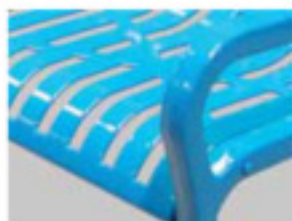

The functional surfaces of our furniture are covered in a copolymer-based thermoplastic powder coating. Thermoplastic is environmentally safe, the coating will never fade, crack, peel, warp, or discolor for the life of the product. Thermoplastic is applied at a thickness of 25-30 mils.

mounting types

P = Portable : no mount

SM = Surface Mount:
concrete anchors
through discs welded
to legs

IG= In-Ground:
J-rods set in concrete
through discs welded
to legs



PORTABLE



SURFACE MOUNT

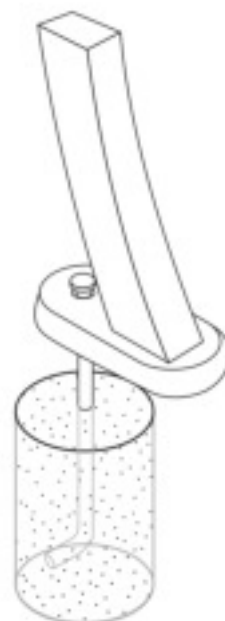

IN-GROUND

All design specifics subject to change. For all products Leisure Craft reserves the right to make adjustments due to changing market conditions, product discontinuation, legislative requirements or other circumstances. © 2009 Leisure Craft, Inc.

(800)553-2476 • sales@kaypark.com • 1301 Pine St. Janesville, IA 50647

